

Recessed Downlight

Product Code
OPTIDL18AR35W220V
OPTIDL18AR35W220VD



IP rating	54
Ik rating	8
Source type	High power LED
Source life time	>50,000h at 25°C ambient temperature
CRI	>90
Step McAdam	3
Source flux	4200 lm
Source efficiency	120 lm/W
Delivered flux	2800 lm
Delivered efficiency	80 lm/W
Input power	35W
Supply voltage	220~240V AC
Insulation Class	insulation class III
Power supply	Lifud driver constant current
Material	aluminum
Light colour/CCT	3000K/4000K/6000K
Beam angle	12/24/38/55°
Mounting	Surface Mounted
Reflector color	Black/White/Silver
Finishing	white/black

Technical drawing

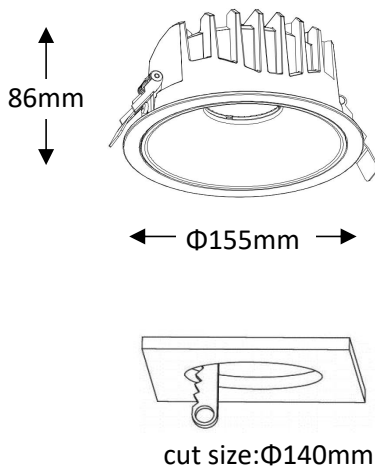

Temperature limits

Working temperature	-30C° to +50C°
Storage temperature	-50C° to +80C°

Light control

ON/off, optional DALI dimming

Construction

- Cast aluminum trim routes heat away from electrical components
- Adjustable, spring loaded retention tabs ensure secure fixture retention
- Certified for direct contact with insulation

Warranty

- 5-year limited system warranty standard
- Warranty does not cover product failure due to an overvoltage event (power surge)
- For installations where power surge may be possible, NICOR recommends installing additional surge protection at the electrical distribution panel

Photometrics

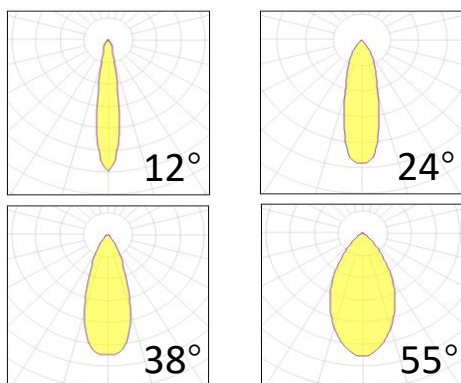

Specifications

